

# VANTAA CUP



VANTAA (FIN)

2013-11-09 - 2013-11-10 2013

Résultats - Results

Lutte Greco-Romaine - Greco-Roman



**Liste des arbitres / Referee list****VANTAA CUP**

<b>N°</b>	<b>Licence</b>	<b>Pays Country</b>	<b>Nom - Last Name</b>	<b>Prénom - First Name</b>
	2746	ALG	BENCHAITA	Hachemi
	5376	ALG	FEKIR	Noureddine
	4575	DEN	ATAY	Zeynel
	3524	EST	AROLD	Peep
	4273	EST	RENTER	Tanel
	4594	FIN	AALTO	Anni-Maija
	3875	FIN	KOIVULAHTI	Jukka
	4275	FIN	KUNTTU	Juha
	5280	FIN	KURONEN	Jali
	4639	FIN	KYLMÄ,,NIENI	Kirsi
	4220	FIN	PETROVIC	Stevo
	3793	FIN	PILLI	Ilmo
	4988	FIN	SARANPÄ,,Ä,,	Mikko
	2083	FIN	TOIVOLA	Karri
	4301	FIN	TYNNINEN	Eero
	2082	FIN	VEHVILÄ,,INEN	Pertti
	3966	FIN	VUORI	Mika
	4987	FIN	YLIMÄ,,KI	Susanna
	4990	RUS	DOLGUSHEV	Nikolai
	4996	RUS	KOVALENKO	Sergei
	4653	RUS	NEROBEEV	Nikolay
	0007	SUI	NOBS	Marianne
	3385	SWE	KAKAVAND	Djalal
	5253	SWE	TAAVELA	Katja

Nombre d'arbitres - Number of Referee

24



## Liste des nations / Countries List

### VANTAA CUP

STYLE GR



#### Pays - Country

	Ä,Ä,NEKOSKEN HUIMA	Ä,H
	ALGERIA	ALG
	ARGENTINA	ARG
	ESTONIA	EST
	FINLAND	FIN
	HELSINGIN HAKA	Haka
	HELSINGIN TARMO	HeTa
	HYVINKÄ,Ä,N PAINIKLUBI	HyPk
	ILMAJOEN KISAILIJAT	IK
	IRAQ	IRQ
	JÄ,RVENPÄ,Ä,N VOIMAILIJAT	JÄαVo
	KAUHAJOEN KARHU	KaKa
	KOOVEE	Koovee
	KOTKAN PAINIMIEHET	KPM
	LAPPEENRANNAN TYÄ-VÄ,EN	LrTU
	URHEILIJAT	
	LAPUAN VIRKIÄ,	VirkiÄα
	LATVIA	LAT
	LITHUANIA	LTU
	OULUN PYRINTÄ-	OP
	PERÄ,SEINÄ,JOEN TOIVE	PeTo
	RUSSIA	RUS
	SAINT PETERSBURG	StP
	SEINÄ,JOEN PAINIMIEHET	SPM
	VAASAN TOVERIT	VaaTo
	YLÄ,-TIKKURILAN KIPINÄ,	YTK

Nombre de nations - Number of Countries 25



**Nombre d'engagés par nation / Number of Entries By Country**

**VANTAA CUP**

**STYLE GR**



<i>Pays - Country</i>	<i>120 KG</i>	<i>55 KG</i>	<i>60 KG</i>	<i>66 KG</i>	<i>74 KG</i>	<i>84 KG</i>	<i>96 KG</i>	<i>TOTAL</i>
Å,,H			1					1
ALG		1	1	2	1	1		6
ARG					1			1
EST		2			2	1	1	6
FIN	1	1	1	1	1	1	1	7
Haka					1			1
HeTa				1		1		2
HyPk				1				1
IK			1	2	1			4
IRQ					1		1	2
JÃ¤Vo			3		1	1		5
KaKa			1					1
Koovee			1		1			2
KPM							1	1
LAT				1				1
LrTU						1		1
LTU	1			1		1		3
OP			1	1		1		3
PeTo				1			1	2
RUS	2	1	2	1	2		1	9
SPM		1						1
StP			1		1	2	1	5
VaaTo		1						1
VirkiÃ¤		1				1		2
YTK					1	1	1	3
<b>TOTAL</b>	<b>4</b>	<b>8</b>	<b>13</b>	<b>12</b>	<b>14</b>	<b>12</b>	<b>8</b>	<b>71</b>

**Nombre de nations - Number of Countries** 25



## Liste des Engagés par pays / Entry-List By Country

### VANTAA CUP

#### STYLE GR



#### ALGERIA (ALG)

##### Lutteur(s) / Wrestler(s) :

55 kg	BENBRIH, Billel
60 kg	DJEDAIET, Mouatez
66 kg	BENAISSA, Tarek Aziz BOUDJEMLINE, Akrem
74 kg	BENABIDI, Belkacem Anis
84 kg	BOUDJEMLINE, Adem

#### ARGENTINA (ARG)

##### Lutteur(s) / Wrestler(s) :

74 kg	PRUDENZANO, Maximiliano
-------	-------------------------

#### ESTONIA (EST)

##### Lutteur(s) / Wrestler(s) :

55 kg	MÄ„GISALU, Mario MERISALU, Markos
74 kg	PAJUVIDIK, Rauno TÄ•GEN, Silver
84 kg	TOOM, Alo
96 kg	ARUSAAR, Ardo

#### FINLAND (FIN)

##### Lutteur(s) / Wrestler(s) :

###### Ä„H

60 kg	PUUKARI, Toni
-------	---------------

###### FIN

120 kg	HUOVINEN, Juuso
55 kg	OHUKAINEN, Niko
60 kg	PASANEN, Ville
66 kg	ZAKOLE, Jumaa
74 kg	SUOMINEN, Veli-Karri
84 kg	LARMILA, Joonas
96 kg	KALLIO, Timo

###### Haka

74 kg	HIRVI, Lari
-------	-------------

###### HeTa

66 kg	MARTIKAINEN, Petteri
-------	----------------------



## Liste des Engagés par pays / Entry-List By Country

### VANTAA CUP

#### STYLE GR

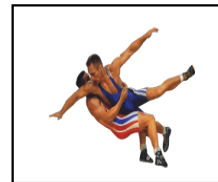

84 kg	Ä...LANDER, Jarno
<u>HyPk</u>	
66 kg	HALMESMÄ,,KI, Tero
<u>IK</u>	
60 kg	LATVALA, Juuso
66 kg	ERKKOLA, Niko LIPASTI, Matias
74 kg	METSOMÄ,,KI, Toni
<u>JÄaVo</u>	
60 kg	MANNINEN, Vili OJALA, Toni TORJAMA, Jami
74 kg	LEHTONEN, Oskari
84 kg	TARINO, Akseli
<u>KaKa</u>	
60 kg	HAAPAMÄ,,KI, Jani
<u>Koovee</u>	
60 kg	NIEMISTÄ–, Jussi-Pekka
74 kg	MOISIO, Valtteri
<u>KPM</u>	
96 kg	KLAMI, Arttu-Petteri
<u>LrTU</u>	
84 kg	LIKKANEN, Riku
<u>OP</u>	
60 kg	LINDGREN, Antti
66 kg	TERVONEN, Niko
84 kg	KARJALAINEN, Janne
<u>PeTo</u>	
66 kg	TEPPO, Juho
96 kg	RIIHIOJA, Oskari
<u>SPM</u>	
55 kg	SYRJÄ,, Rami
<u>VaaTo</u>	
55 kg	AHMADI, Toufan
<u>VirkiÄa</u>	
55 kg	PELTOKANGAS, Mikko
84 kg	LUOMA, Petri
<u>YTK</u>	
74 kg	VÄ,,REKOSKI, Verner
84 kg	MÄ,,KINEN, Antti
96 kg	LAHTI, Tuomas



## Liste des Engagés par pays / Entry-List By Country

### VANTAA CUP

STYLE GR



#### IRAQ (IRQ)

**Lutteur(s) / Wrestler(s) :**

74 kg	AL KHANFR, Hussein
96 kg	FAKHRULDEEN, Ammar

#### LATVIA (LAT)

**Lutteur(s) / Wrestler(s) :**

66 kg	KALNAKARKLIS, Kristups
-------	------------------------

#### LITHUANIA (LTU)

**Lutteur(s) / Wrestler(s) :**

120 kg	KNYSTAUTAS, Mantas
66 kg	VENCKAITIS, Edgaras
84 kg	KAZAKEVIC, Aleksandr

#### RUSSIA (RUS)

**Lutteur(s) / Wrestler(s) :**

RUS

120 kg	NAZHMUDINOV, Kurban SHCHUR, Vitalii
55 kg	AKOPIAN, Aram
60 kg	FEDOTOV, Ivan MINASYAN, Ruben
66 kg	SURKOV, Maksim
74 kg	ISAKOV, Ruslan KALANDIYA, Irakliy
96 kg	LABAZANOV, Nokhcho

StP

60 kg	AKOPYAN, David
74 kg	LABAZANOV, Chingiz
84 kg	AKHMEDOV, Ramil DUGUCHIEV, Movsar
96 kg	SAFARYAN, Maksim



# Feuille de compétition / Competition Sheet

## VANTAA CUP

STYLE : GR 120 kg



### TOUR : 1

1	$\frac{1}{2}$	KNYSTAUTAS Mantas (LTU)	P1	P2	P3	2	SHCHUR Vitalii (RUS)
			2	0	0		
2	$\frac{4}{6}$	SHCHUR Vitalii (RUS)	P1	P2	P3	4	NAZHMUDINOV Kurban (RUS)
			6	0	0		
3	$\frac{0}{0}$	HUOVINEN Juuso (FIN)	P1	P2	P3	4	NAZHMUDINOV Kurban (RUS)
			0	0	0		
4	$\frac{4}{8}$	NAZHMUDINOV Kurban (RUS)	P1	P2	P3	8	0
			8	0	0		

### TOUR : 2

1	$\frac{3}{8}$	KNYSTAUTAS Mantas (LTU)	P1	P2	P3	1	KNYSTAUTAS Mantas (LTU)
			8	0	0		
3	$\frac{1}{3}$	HUOVINEN Juuso (FIN)	P1	P2	P3	3	0
			3	0	0		
2	$\frac{4}{7}$	SHCHUR Vitalii (RUS)	P1	P2	P3	2	SHCHUR Vitalii (RUS)
			7	0	0		
4	$\frac{0}{0}$	NAZHMUDINOV Kurban (RUS)	P1	P2	P3	0	0
			0	0	0		

### TOUR : 3

1	$\frac{1}{5}$	KNYSTAUTAS Mantas (LTU)	P1	P2	P3	5	0
			5	0	0		
4	$\frac{3}{8}$	NAZHMUDINOV Kurban (RUS)	P1	P2	P3	8	0
			8	0	0		
2	$\frac{4}{7}$	SHCHUR Vitalii (RUS)	P1	P2	P3	2	SHCHUR Vitalii (RUS)
			7	0	0		
3	$\frac{0}{0}$	HUOVINEN Juuso (FIN)	P1	P2	P3	0	0
			0	0	0		

### Classement

Cl	Pays	Nom	Points
1	RUS	SHCHUR Vitalii	12
2	RUS	NAZHMUDINOV Kurban	7
3	LTU	KNYSTAUTAS Mantas	5
4	FIN	HUOVINEN Juuso	1





Classement

VANTAA CUP

STYLE : GR 120 kg

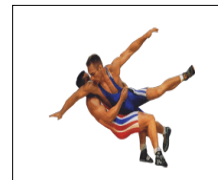

1 - Or / Gold



SHCHUR Vitalii

2 - Argent / Silver



NAZHMUDINOV Kurban

3 - Bronze



KNYSTAUTAS Mantas

Classement	Nom - Name	Pays - Country	Points
1	SHCHUR Vitalii	RUS	12
2	NAZHMUDINOV Kurban	RUS	7
3	KNYSTAUTAS Mantas	LTU	5
4	HUOVINEN Juuso	FIN	1



# Feuille de compétition / Competition Sheet

## VANTAA CUP

STYLE : GR 55 kg



### Classement

Cl	Pays	Nom
1	RUS	AKOPIAN Aram
2	VaaTo	AHMADI Toufan
3	FIN	OHUKAINEN Niko
3	VirkiÄä	PELTOKANGAS Mikko
5	ALG	BENBRIH Billel
5	SPM	SYRJÄ,, Rami
7	EST	MÄ,,GISALU Mario
8	EST	MERISALU Markos

### REPECHAGE

#### REPECHAGE FINALISTE 1

2	0	ALG	P1	P2	P3
0	0		0	0	0
4	4	FIN	P1	P2	P3
7	7		7	0	0

4 OHUKAINEN Niko (FIN)

Mdaille de Bronze

#### REPECHAGE FINALISTE 2

7	0	SPM	P1	P2	P3
0	0		0	0	0
6	3	VirkiÄä	P1	P2	P3
3	3		3	0	0

6 PELTOKANGAS M. (VirkiÄä)

Mdaille de Bronze



**Classement**  
**VANTAA CUP**

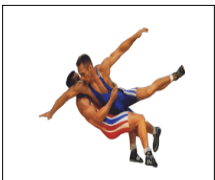

STYLE : GR 55 kg

1 - Or / Gold



AKOPIAN Aram

2 - Argent / Silver



AHMADI Toufan

3 - Bronze



OHUKAINEN Niko



PELTOKANGAS Mikko

Classement	Nom - Name	Pays - Country
1	AKOPIAN Aram	RUS
2	AHMADI Toufan	VaaTo
3	OHUKAINEN Niko	FIN
3	PELTOKANGAS Mikko	VirkiÅª
5	BENBRIH Billel	ALG
5	SYRJÄ,, Rami	SPM
7	MÄ,,GISALU Mario	EST
8	MERISALU Markos	EST



# Feuille de compétition / Competition Sheet

## VANTAA CUP

STYLE : GR 60 kg



8 NIEMISTÄ- J. (Koovee)

### Classement

Cl	Pays	Nom
1	Koovee	NIEMISTÄ- Jussi-Pekka
2	RUS	FEDOTOV Ivan
3	FIN	PASANEN Ville
3	KaKa	HAAPAMÄKI Jani
5	JÅVo	TORJAMA Jami
5	StP	AKOPYAN David
7	JÅVo	MANNINEN Vili
8	IK	LATVALA Juuso
9	Ä,H	PUUKARI Toni
10	RUS	MINASYAN Ruben
11	OP	LINDGREN Antti
12	ALG	DJEDAIET Mouatez
13	JÅVo	OJALA Toni

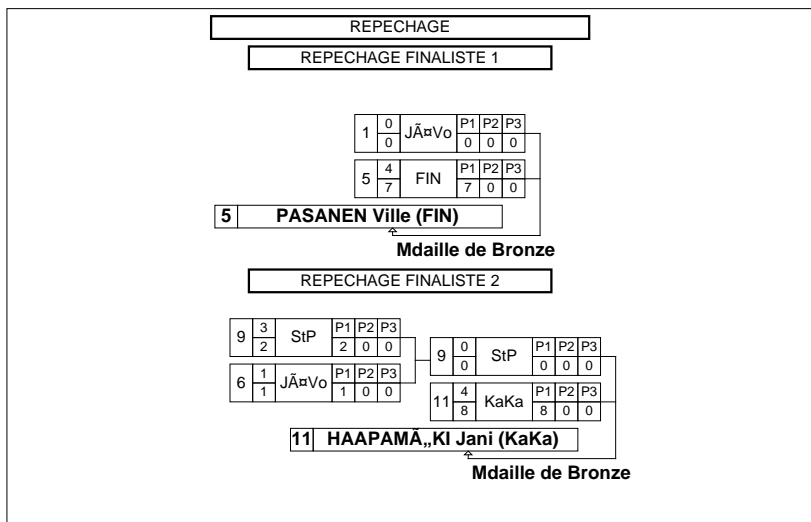



Classement

VANTAA CUP

STYLE : GR 60 kg

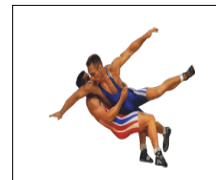

1 - Or / Gold



NIEMISTÄ– Jussi-Pekka

2 - Argent / Silver



FEDOTOV Ivan

3 - Bronze



PASANEN Ville



HAAPAMÄKI Jani

Classement	Nom - Name	Pays - Country
1	NIEMISTÄ– J.	Koovee
2	FEDOTOV Ivan	RUS
3	PASANEN Ville	FIN
3	HAAPAMÄKI Jani	KaKa
5	TORJAMA Jami	JÄrVo
5	AKOPYAN David	StP
7	MANNINEN Vili	JÄrVo
8	LATVALA Juuso	IK
9	PUUKARI Toni	Ä,H
10	MINASYAN Ruben	RUS
11	LINDGREN Antti	OP
12	DJEDAIET Mouatez	ALG
13	OJALA Toni	JÄrVo



# Feuille de compétition / Competition Sheet

## VANTAA CUP

STYLE : GR 66 kg

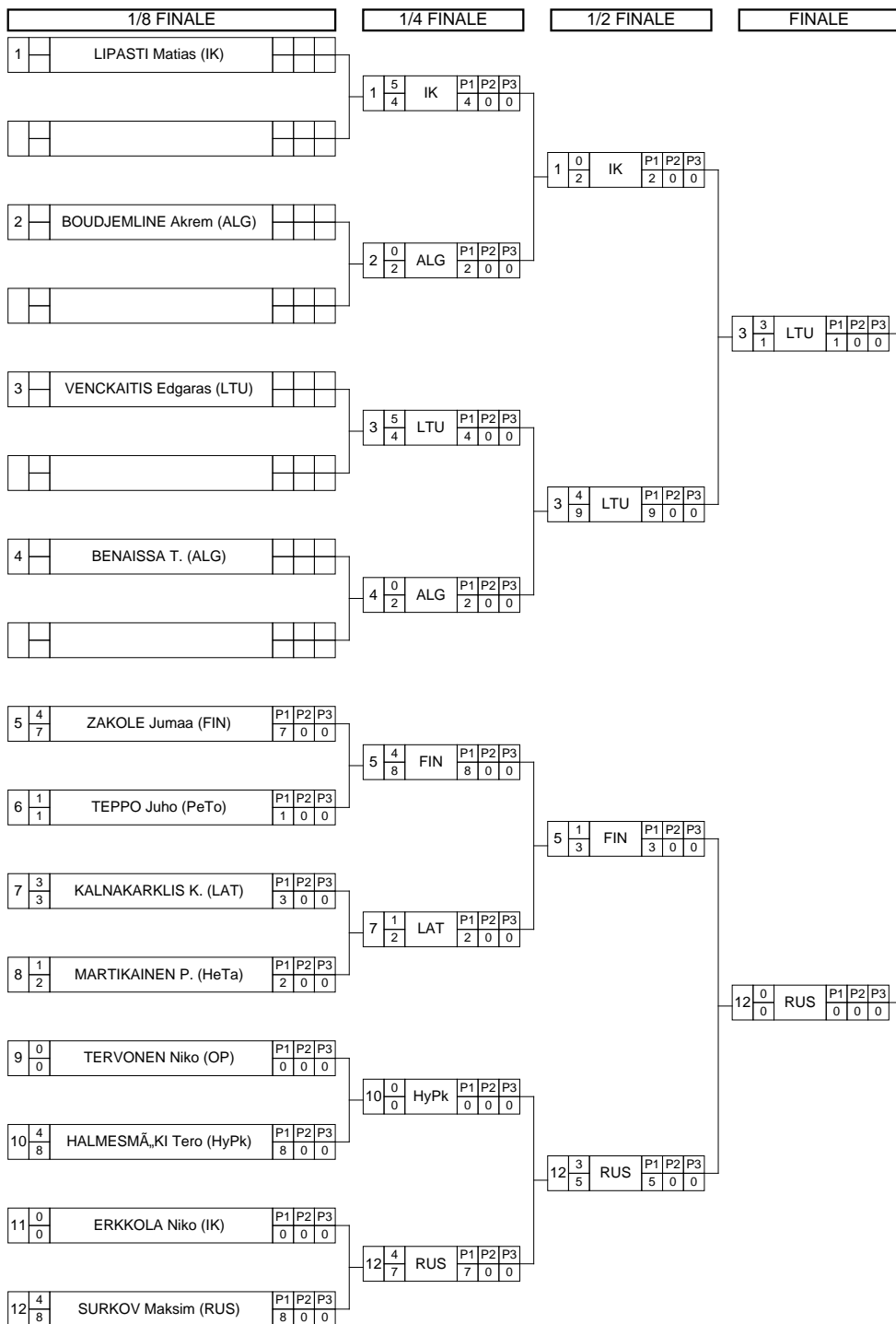

**3 VENCKAITIS Edgaras (LTU)**

### Classement

Cl	Pays	Nom
1	LTU	VENCKAITIS Edgaras
2	RUS	SURKOV Maksim
3	ALG	BENAISSA Tarek Aziz
3	FIN	ZAKOLE Jumaa
5	IK	LIPASTI Matias
5	HyPk	HALMESMÄ, KI Tero
7	LAT	KALNAKARKLIS Kristups
8	HeTa	MARTIKAINEN Petteri
9	PeTo	TEPPO Juho
10	ALG	BOUDJEMLINE Akrem
11	OP	TERVONEN Niko
12	IK	ERKKOLA Niko

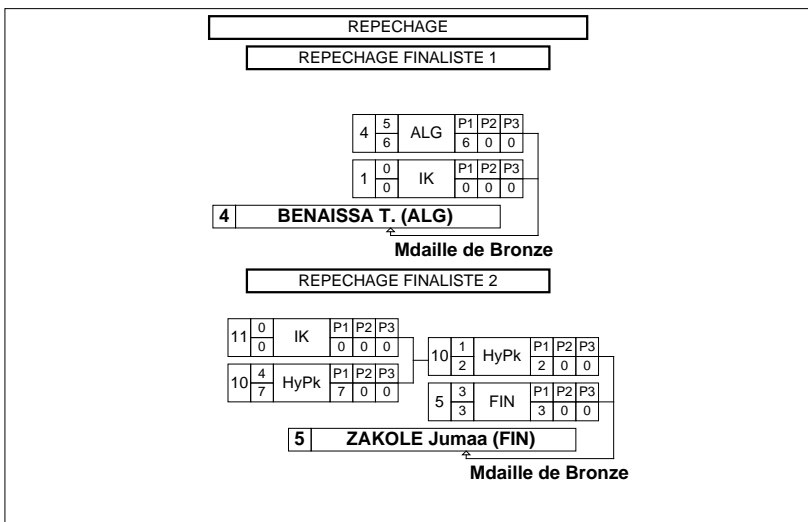



Classement

VANTAA CUP

STYLE : GR 66 kg



1 - Or / Gold



VENCKAITIS Edgaras

2 - Argent / Silver



SURKOV Maksim

3 - Bronze



BENAISSA Tarek Aziz



ZAKOLE Jumaa

Classement	Nom - Name	Pays - Country
1	VENCKAITIS Edgaras	LTU
2	SURKOV Maksim	RUS
3	BENAISSA Tarek Aziz	ALG
3	ZAKOLE Jumaa	FIN
5	LIPASTI Matias	IK
5	HALMESMÄKI Tero	HyPk
7	KALNAKARKKLIS K.	LAT
8	MARTIKAINEN Petteri	HeTa
9	TEPPO Juho	PeTo
10	BOUDJEMLINE Akrem	ALG
11	TERVONEN Niko	OP
12	ERKKOLA Niko	IK



# Feuille de compétition / Competition Sheet

## VANTAA CUP

STYLE : GR 74 kg

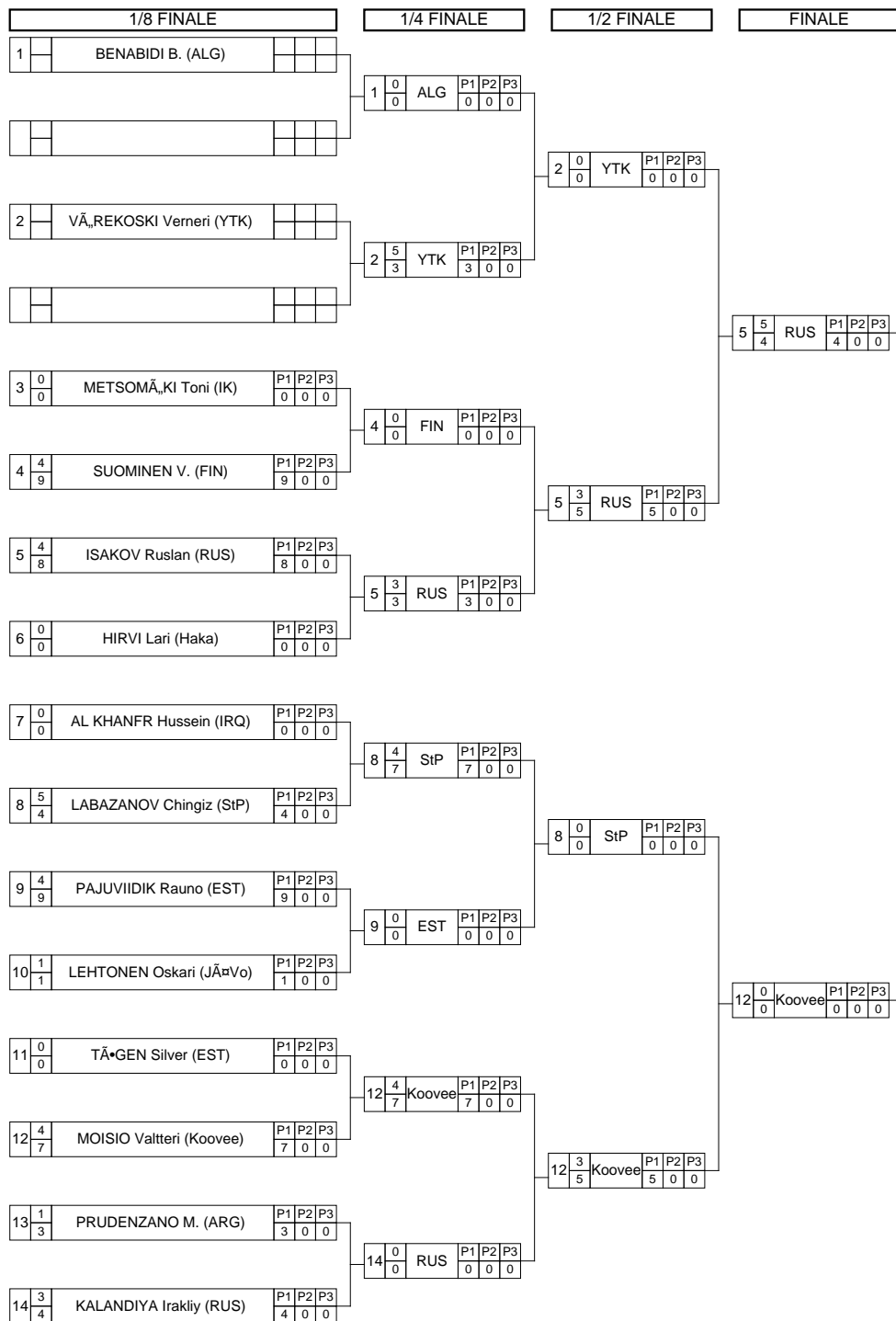

5 ISAKOV Ruslan (RUS)

### Classement

Cl	Pays	Nom
1	RUS	ISAKOV Ruslan
2	Koovee	MOISIO Valteri
3	FIN	SUOMINEN Veli-Karri
3	StP	LABAZANOV Chingiz
5	YTK	VÄ,,REKOSKI Veneri
5	EST	TÄ,,GEN Silver
7	EST	PAJUVIDIK Rauno
8	RUS	KALANDIYA Irakliy
9	ARG	PRUDENZANO Maximiliano
10	Haka	HIRVI Lari
11	JÄ,,Vo	LEHTONEN Oskari
12	ALG	BENABIDI Belkacem Anis
13	IRQ	AL KHANFR Hussein
14	IK	METSOMA,,KI Toni

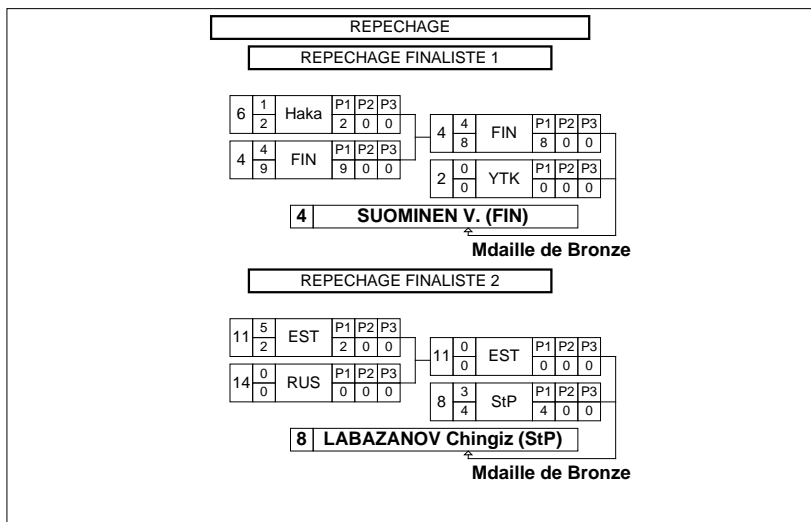



**Classement****VANTAA CUP**

STYLE : GR 74 kg

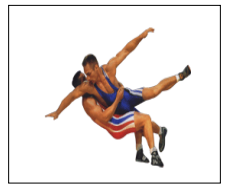
**1 - Or / Gold**

ISAKOV Ruslan

**2 - Argent / Silver**

MOISIO Valtteri

**3 - Bronze**

SUOMINEN Veli-Karri



LABAZANOV Chingiz

<i>Classement</i>	<i>Nom - Name</i>	<i>Pays - Country</i>
1	ISAKOV Ruslan	RUS
2	MOISIO Valtteri	Koovee
3	SUOMINEN Veli-Karri	FIN
3	LABAZANOV Chingiz	StP
5	VÄÄREKOSKI Verner	YTK
5	TÄÄGEN Silver	EST
7	PAJUVIDIK Rauno	EST
8	KALANDIYA Irakliy	RUS
9	PRUDENZANO M.	ARG
10	HIRVI Lari	Haka
11	LEHTONEN Oskari	JÄrVo
12	BENABIDI B.	ALG
13	AL KHANFR Hussein	IRQ
14	METSOMÄKI Toni	IK



# Feuille de compétition / Competition Sheet

## VANTAA CUP

STYLE : GR 84 kg



10 DUGUCHIEV Movsar (StP)

### Classement

Cl	Pays	Nom
1	StP	DUGUCHIEV Movsar
2	LTU	KAZAKEVIC Aleksandr
3	EST	TOOM Alo
3	HeTa	Ä...LANDER Jarno
5	VirkiÄä	LUOMA Petri
5	YTK	MÄ...KINEN Antti
7	ALG	BOUDJEMLINE Adem
8	FIN	LARMILA Joonas
9	OP	KARJALAINEN Janne
10	StP	AKHMEDOV Ramil
11	JÄäVo	TARINO Akseli
12	LrTU	LIKKANEN Riku

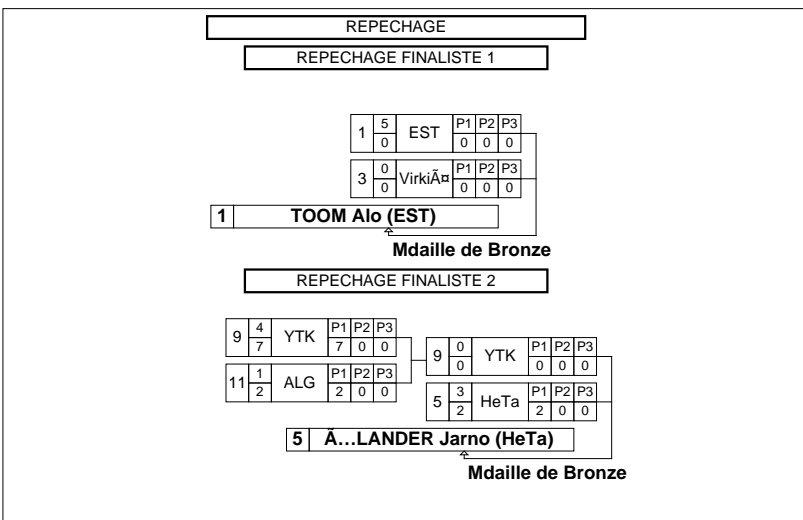



**Classement**  
**VANTAA CUP**

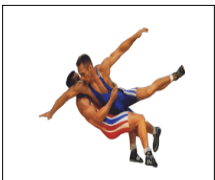

STYLE : GR 84 kg

1 - Or / Gold



DUGUCHIEV Movsar

2 - Argent / Silver



KAZAKEVIC Aleksandr

3 - Bronze



TOOM Alo



Ä...LANDER Jarno

Classement	Nom - Name	Pays - Country
1	DUGUCHIEV Movsar	StP
2	KAZAKEVIC Aleksandr	LTU
3	TOOM Alo	EST
3	Ä...LANDER Jarno	HeTa
5	LUOMA Petri	VirkiÄ
5	MÄ„KINEN Antti	YTK
7	BOUDJEMLINE Adem	ALG
8	LARMILA Joonas	FIN
9	KARJALAINEN Janne	OP
10	AKHMEDOV Ramil	StP
11	TARINO Akseli	JÄ»Vo
12	LIKKANEN Riku	LrTU



# Feuille de compétition / Competition Sheet

## VANTAA CUP

STYLE : GR 96 kg

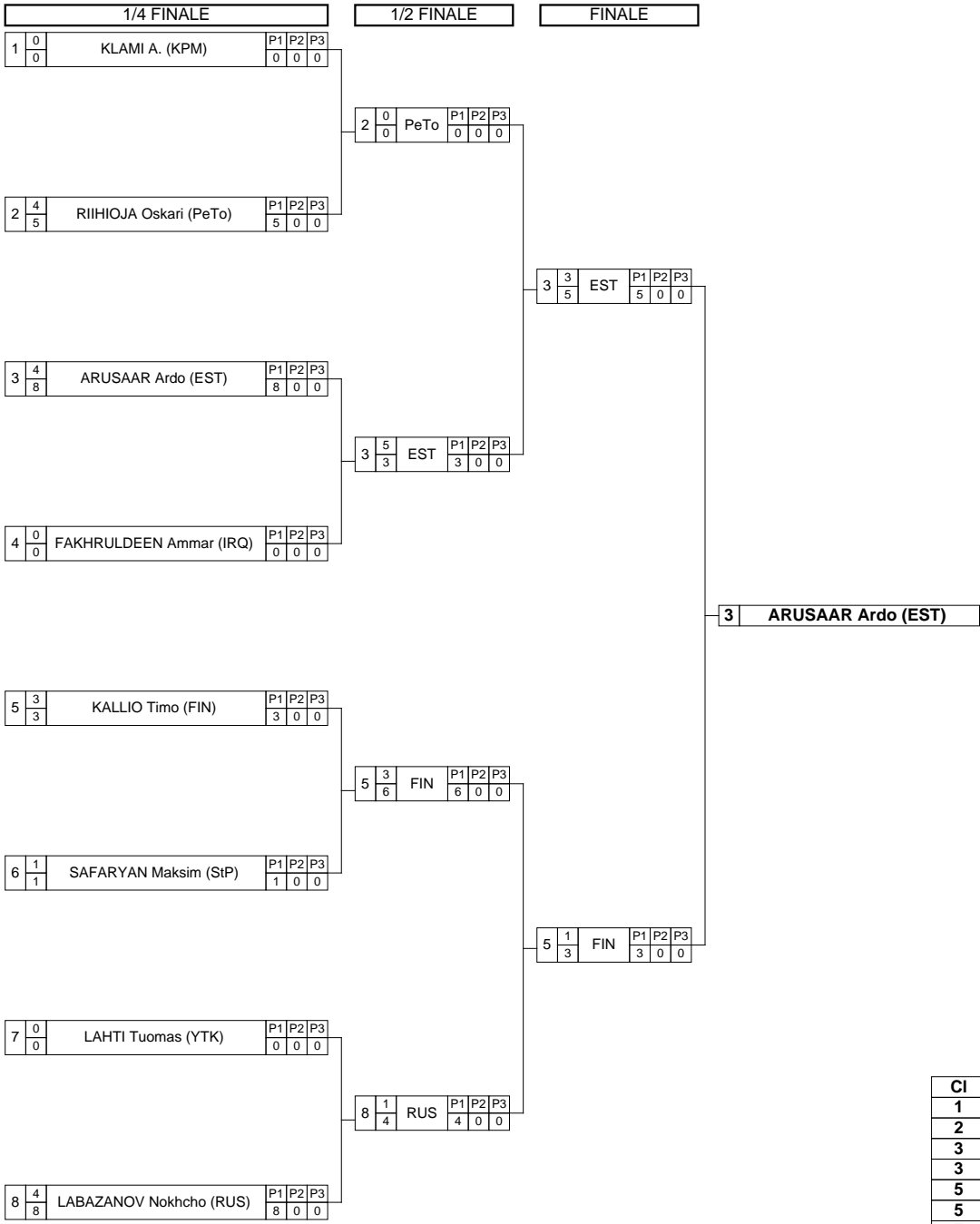
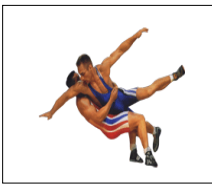

Classement

Cl	Pays	Nom
1	EST	ARUSAAR Ardo
2	FIN	KALLIO Timo
3	PeTo	RIIHIOJA Oskari
3	StP	SAFARYAN Maksim
5	IRQ	FAKHRULDEEN Ammar
5	RUS	LABAZANOV Nokhcho
7	KPM	KLAMI Arttu-Petteri
8	YTK	LAHTI Tuomas

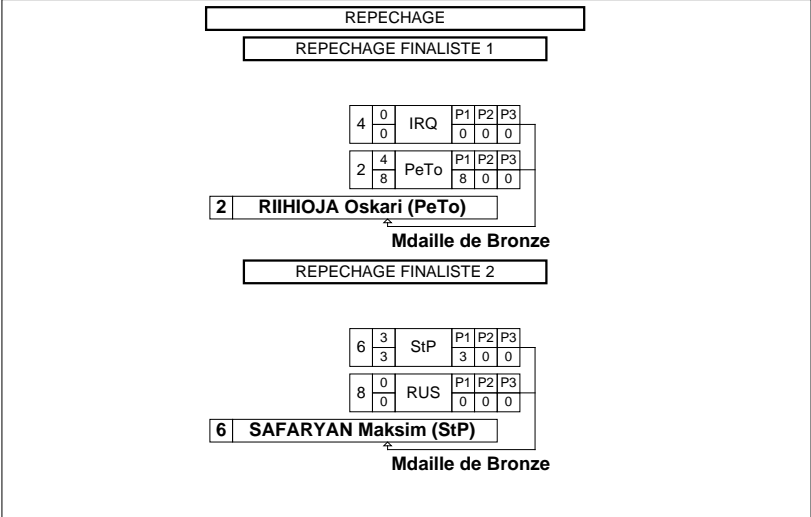



Classement

VANTAA CUP

STYLE : GR 96 kg

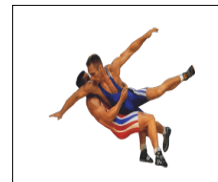

1 - Or / Gold



ARUSAAR Ardo

2 - Argent / Silver



KALLIO Timo

3 - Bronze



RIIHIOJA Oskari



SAFARYAN Maksim

Classement	Nom - Name	Pays - Country
1	ARUSAAR Ardo	EST
2	KALLIO Timo	FIN
3	RIIHIOJA Oskari	PeTo
3	SAFARYAN Maksim	StP
5	FAKHRULDEEN Ammar	IRQ
5	LABAZANOV Nokhcho	RUS
7	KLAMI Arttu-Petteri	KPM
8	LAHTI Tuomas	YTK

